

Varenummer: 4395000481
Beskrivelse: Rota-fix spændelement F48x80
Rustfast stål

Mål

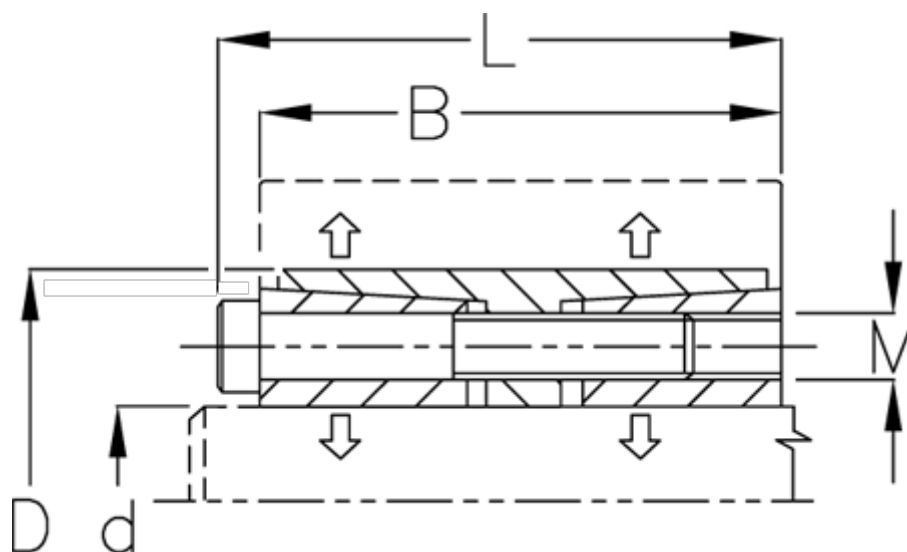

B mm	= 66
d H8 mm	= 48
D mm	= 80
F kN aksialkraft	= 87.7
L mm	= 74
M mm	= M8
Overfladeruhed	= R? ? 3.2 μ m
P N/mm ² fladetryk på aksel/nav	= 32

T Nm drejningsmoment	= 2100
Tolerance	= Aksel h8, Nav H8
Ts Nm boltetilspændingsmoment	= 28.7